

Varenummer: 0106045
 Beskrivelse: Seeger låsering JV 28

Mål

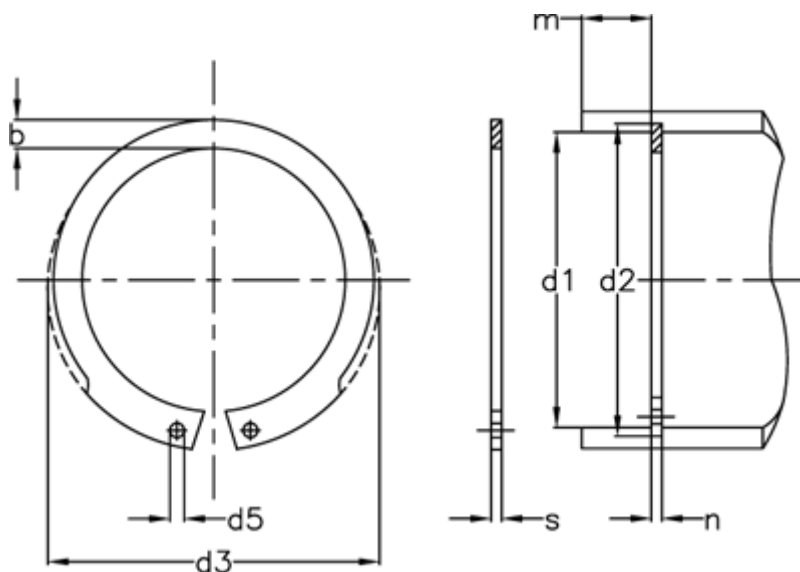

AN mm ²	= 31	FRg kN	= 5.2	Tang	= ZGJ-1
b	= 3.1	FR kN	= 15.3	tol	= -0.06
Betegnelse	= JV 28	g	= 1.0	tol	= +0,50-0,25
d1	= 28	K kN-mm	= 30.4	tol	= +0,21
d2	= 29.4	m min	= 1.30	tol	= 0.1
d3	= 30.1	Nominel træk	= 2.1	vægt kg/1000	= 1.80
d5 min	= 1.5	s	= 1.20		
FN kN	= 5.10	t	= 0.70		